

**FIRST PART
APPROVAL REQUIRED**
 APPROVED BY _____
 DATE _____

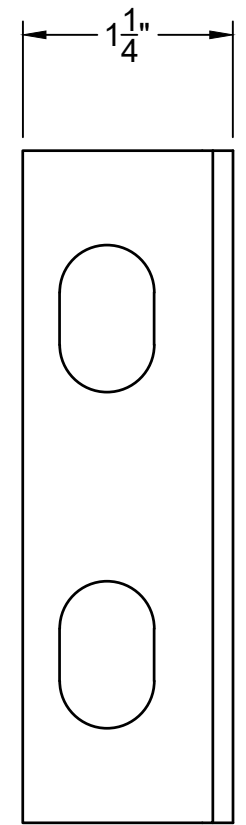

Set of 4

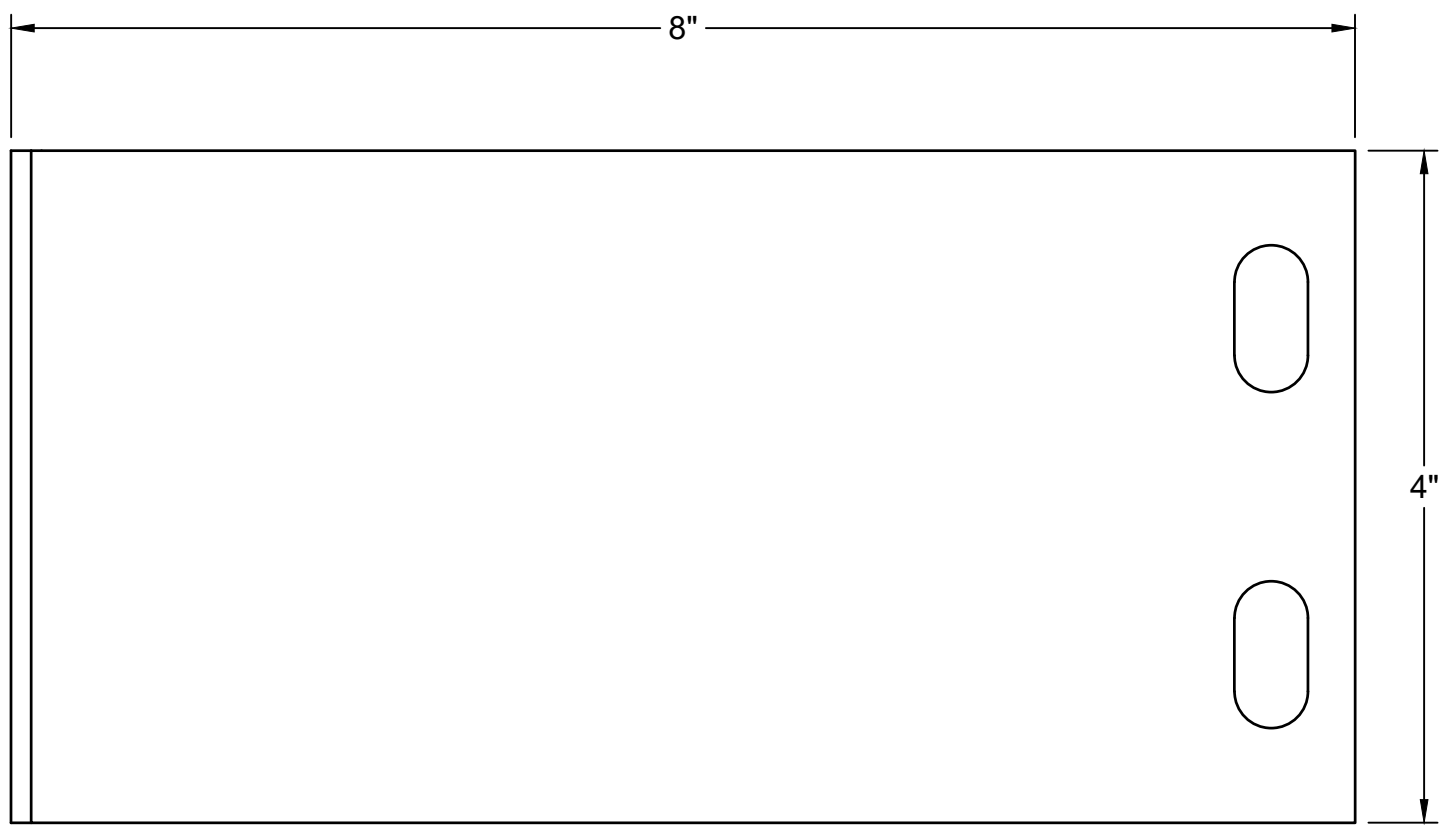
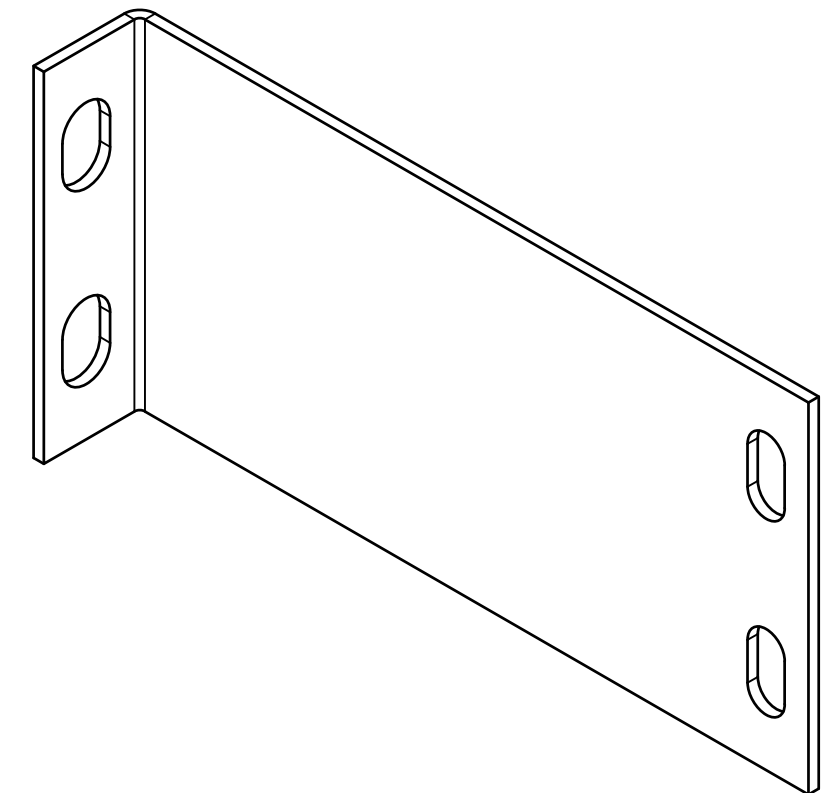

 WIRE & IRON PRODUCTS CO. A DIV. OF JESCO INDUSTRIES P.O. BOX 388 950 ANDERSON ROAD LITCHFIELD MI. 49252 PH. # 1-517-542-2903 FAX # 1-517-542-2501		TITLE		
		Palletgard 8" offset clip 2x1 - 10ga mesh		
SIZE	COLOR	DWG NO	REV	
B	Dk Gray	393230		
DRAWN	Jesse Pifer	3/21/2024	SCALE 7:8	WEIGHT 5 lbs
			SHEET 1/1	