

TOP VIEW

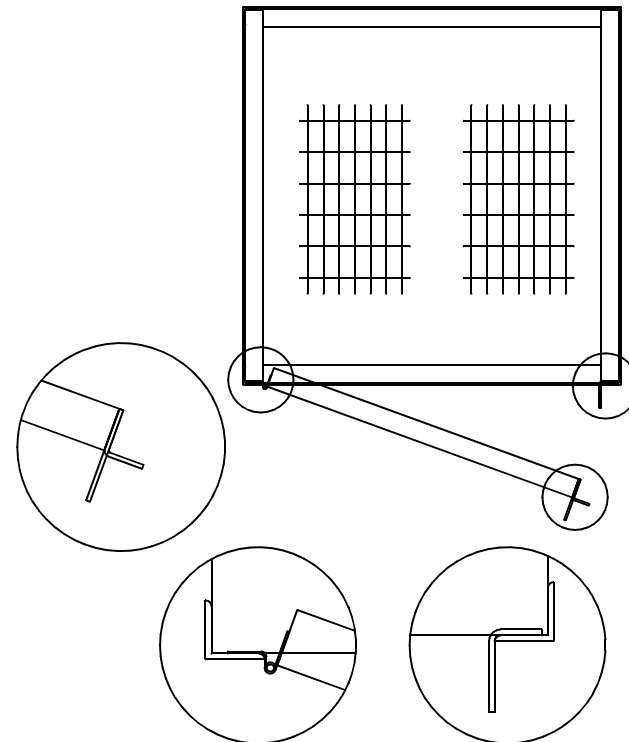

FIRST PART
APPROVAL REQUIRED
APPROVED BY _____
DATE _____

DESCRIPTION			24" 3 DOOR STORAGE LOCKER WITH 2 X 1 MESH
DRAWN BY	SJ	SCALE	MATERIAL
CHK'D		DATE	12/19/02
TRACED		APP'D	383140