

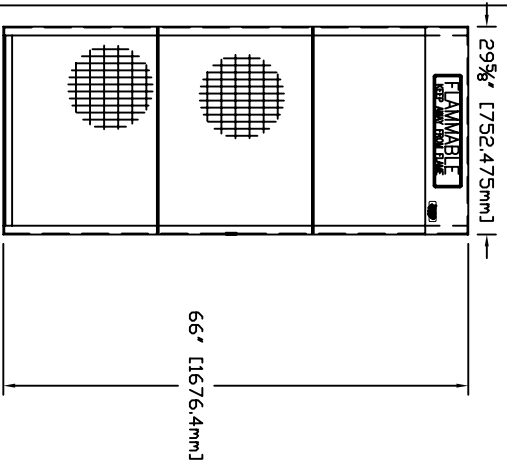

FIRST PART APPROVAL REQUIRED
 APPROVED BY _____
 DATE _____

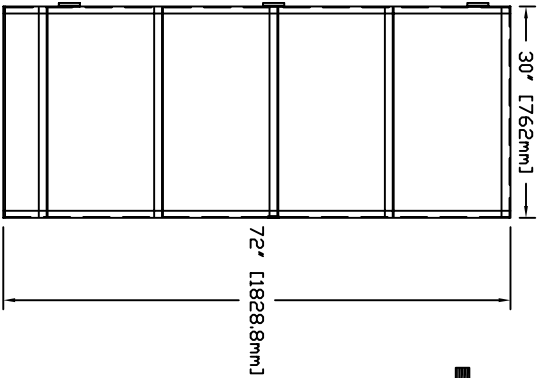

DOOR PANEL
 TWO (2) REQUIRED
 ONE (1) HINGED LEFT
 ONE (1) HINGED RIGHT



DOOR FRAME
 TWO (2) REQUIRED
 ONE (1) HINGED LEFT
 ONE (1) HINGED RIGHT

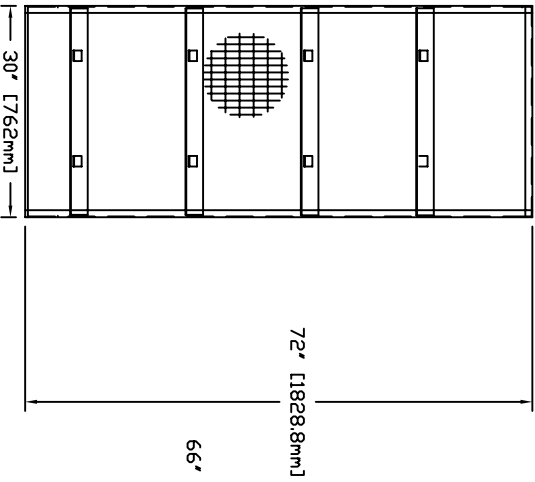

BACK
 TWO (2) REQUIRED

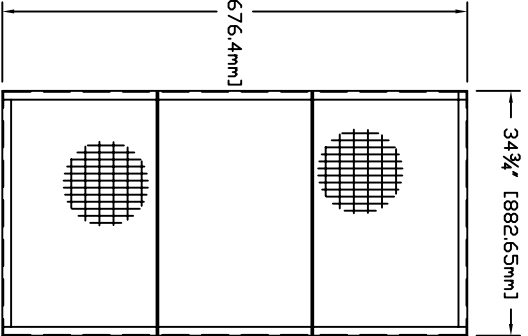

SIDE ELEVATION
 TWO (2) REQUIRED

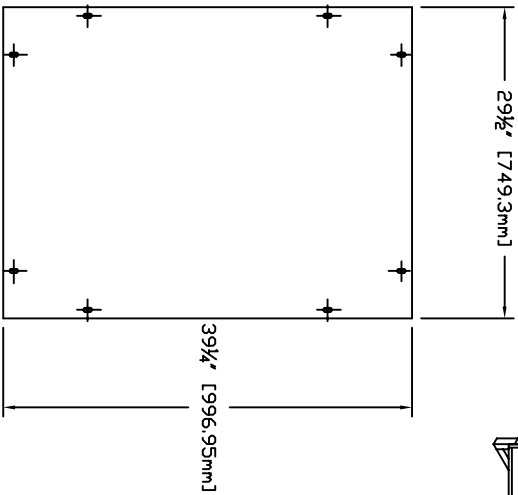
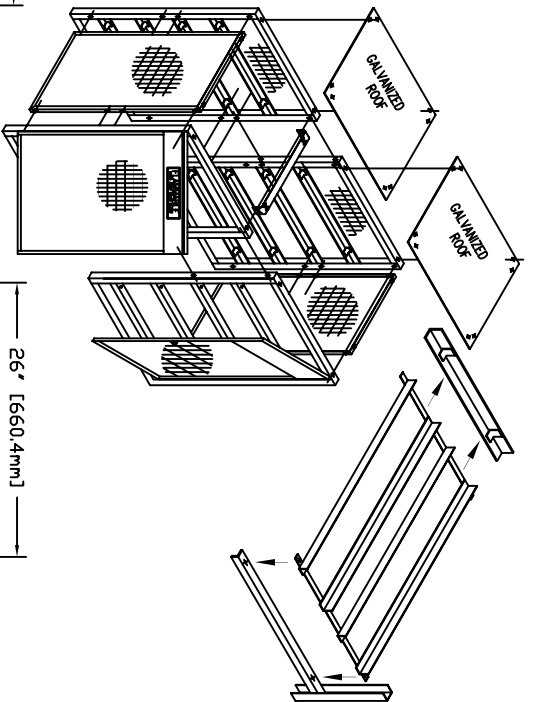

TWO (2) REQUIRED
 TOP DETAIL

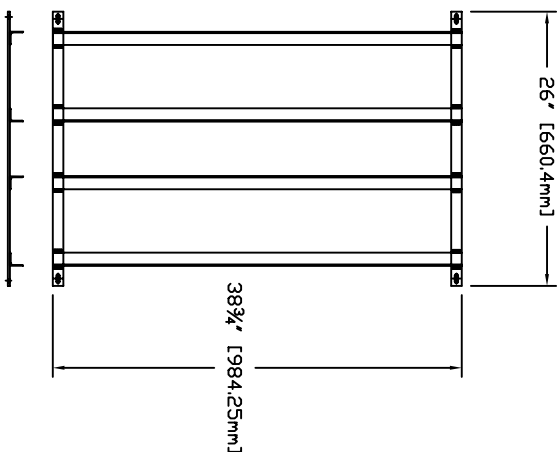

EIGHT (8) REQUIRED
 SHELF LAYOUT

NO.	DESCRIPTION	BY	DATE
20	REV ITEM 15 CHANGED LENGTH	SL	6/21/90
19	UPDATED STOCK LIST #10	SL	9/7/90
18	ITEM 6 REQ. 4 NOT 8	SL	6/2/90
17	UPDATED DETAILS & DIMENSIONS	SL	1-20-88
16	UPDATED BORDER & BROKEN APART	SL	1-20-88
15	MADE INTO THREE SHEETS	JL	8-20-88
14	REVISED ITEM #10 WAS QTY. OF 4	CP	3-20-88
13	REVISED THE STOCK LIST	AM	2-4-88
12	REVISED DIMENSIONS	AM	1-31-87
11	REV PART NOS.	TGM	7-24-86
10	REDISIGNED TO BE K.D. LP CAGE	TGM	3-10-86
9	2X1 MESH WAS EXP. METAL	TGM	3-3-86
8	REV PART NOS.	TGM	1-18-86
7	CHANGED DRAWING NUMBER	TGM	6-28-85
6	UPDATED TO CAD	SAJ	8-22-85

REVISIONS			
NO.	DESCRIPTION	BY	DATE
1	DESCRIPTION		
2	DATE		
3	SCALE		
4	DRAWING NO.		
5	ISSUE NO.		
6	ISSUE DATE		
7	ISSUE BY		
8	ISSUE NO.		
9	ISSUE DATE		
10	ISSUE BY		
11	ISSUE NO.		
12	ISSUE DATE		
13	ISSUE BY		
14	ISSUE NO.		
15	ISSUE DATE		
16	ISSUE BY		
17	ISSUE NO.		
18	ISSUE DATE		
19	ISSUE BY		
20	ISSUE NO.		
21	ISSUE DATE		
22	ISSUE BY		
23	ISSUE NO.		
24	ISSUE DATE		
25	ISSUE BY		
26	ISSUE NO.		
27	ISSUE DATE		
28	ISSUE BY		
29	ISSUE NO.		
30	ISSUE DATE		
31	ISSUE BY		
32	ISSUE NO.		
33	ISSUE DATE		
34	ISSUE BY		
35	ISSUE NO.		
36	ISSUE DATE		
37	ISSUE BY		
38	ISSUE NO.		
39	ISSUE DATE		
40	ISSUE BY		
41	ISSUE NO.		
42	ISSUE DATE		
43	ISSUE BY		
44	ISSUE NO.		
45	ISSUE DATE		
46	ISSUE BY		
47	ISSUE NO.		
48	ISSUE DATE		
49	ISSUE BY		
50	ISSUE NO.		
51	ISSUE DATE		
52	ISSUE BY		
53	ISSUE NO.		
54	ISSUE DATE		
55	ISSUE BY		
56	ISSUE NO.		
57	ISSUE DATE		
58	ISSUE BY		
59	ISSUE NO.		
60	ISSUE DATE		
61	ISSUE BY		
62	ISSUE NO.		
63	ISSUE DATE		
64	ISSUE BY		
65	ISSUE NO.		
66	ISSUE DATE		
67	ISSUE BY		
68	ISSUE NO.		
69	ISSUE DATE		
70	ISSUE BY		
71	ISSUE NO.		
72	ISSUE DATE		
73	ISSUE BY		
74	ISSUE NO.		
75	ISSUE DATE		
76	ISSUE BY		
77	ISSUE NO.		
78	ISSUE DATE		
79	ISSUE BY		
80	ISSUE NO.		
81	ISSUE DATE		
82	ISSUE BY		
83	ISSUE NO.		
84	ISSUE DATE		
85	ISSUE BY		
86	ISSUE NO.		
87	ISSUE DATE		
88	ISSUE BY		
89	ISSUE NO.		
90	ISSUE DATE		
91	ISSUE BY		
92	ISSUE NO.		
93	ISSUE DATE		
94	ISSUE BY		
95	ISSUE NO.		
96	ISSUE DATE		
97	ISSUE BY		
98	ISSUE NO.		
99	ISSUE DATE		
100	ISSUE BY		

DESCRIPTION
 L.P. 16 CYLINDER 60W x 41D x 72H [1524mm x 1041.4mm x 1828.8mm]
 STORAGE LOCKER

DESIGNED BY TGM
 SCALE 1"=1' [25.4mm=304.8mm]
 DATE 11-10-90
 DRAWING NO. 116080