

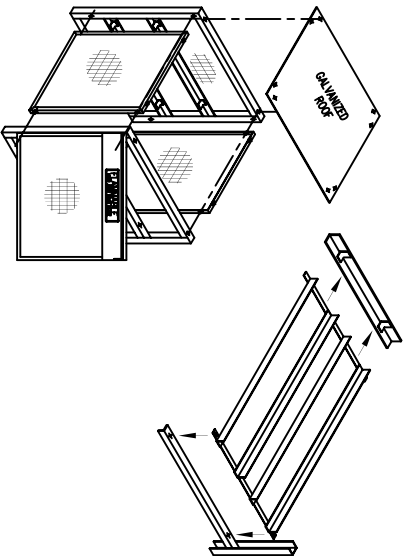

FIRST PART
 APPROVAL REQUIRED
 APPROVED BY _____
 DATE _____

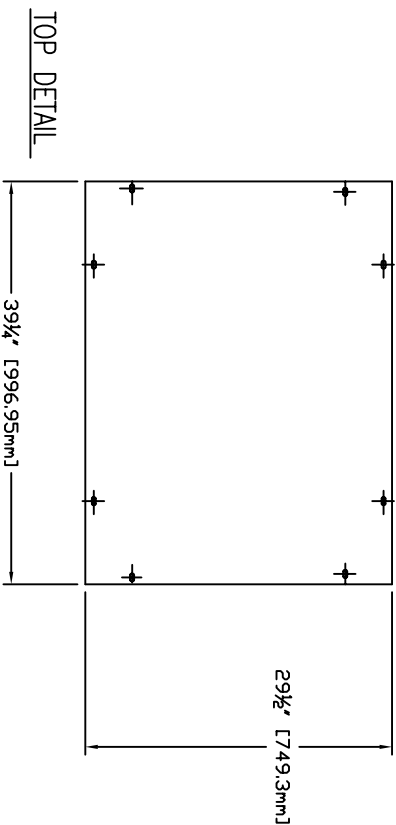
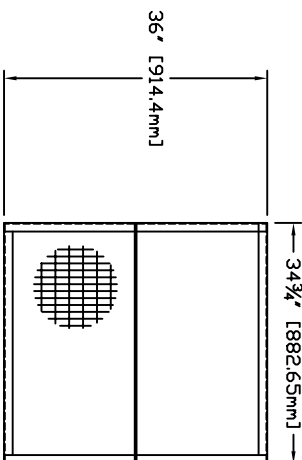
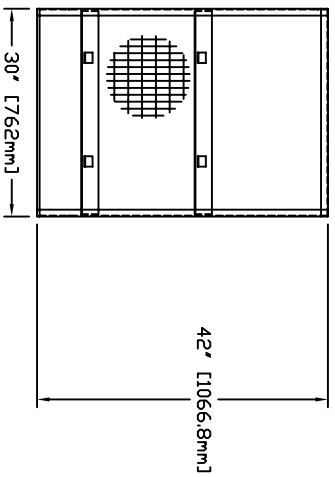
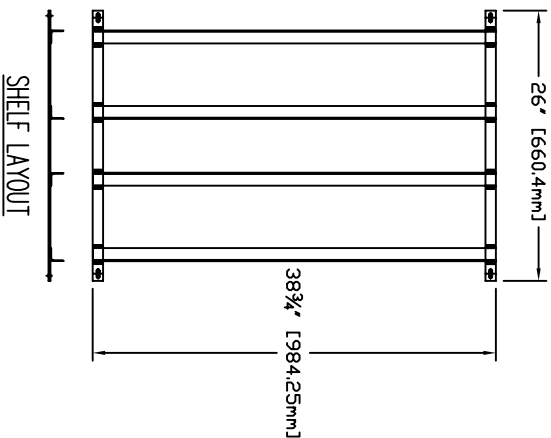
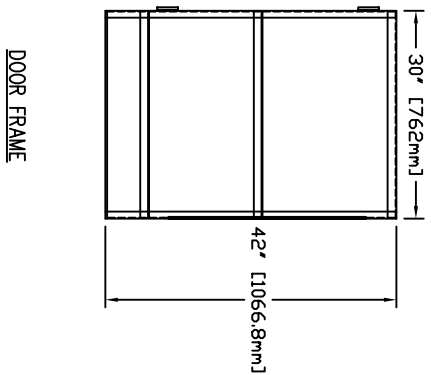
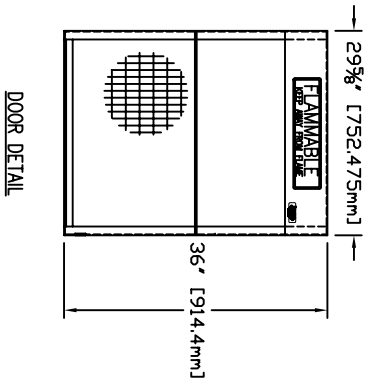

BACK ELEVATION
 DOOR NOT SHOWN

SIDE ELEVATION
 TWO (2) REQUIRED

TOP DETAIL

NO.	DESCRIPTION	BY	DATE
14	ADDED STOCK LIST	JP	2-23-11
13	REV ITEM 15 CHANGED LENGTH	SL	4/11/09
12	UPDATED DWG & DETAILS/STOCK REV PART NOS.	SL	1-28-08
11	REDESIGNED TO BE K.D. L.P. CAGE	TGM	7-24-08
10	2x1 MESH WAS EXP. METAL	TGM	7-2-08
9	REV PART NOS.	TGM	2-6-08
8	CHANGED DWG NO.	TGM	1-16-08
7	UPDATED TO CAD	TGM	1-28-08
6		SAJ	1-17-08
5		TGM	1-30-08
4		TGM	12-4-07
3		MSL	11-7-07
2		MSL	10-18-07
1		MSL	10-7-07

REVISIONS

NO.	DESCRIPTION	BY	DATE
1	L.P. 4 CYLINDER 30Wx41Dx42H [762mmx1041.4mmx1066.8mm] STORAGE LOCKER	TGM	11-12-90
2	SCALE 1"=1' [25.4mm=25.4mm]		
3	DATE 11-12-90		
4	ISSUING NO. 116050		